

## Operating Manual



### **VMD423H**

Voltage and frequency monitor  
for monitoring of 3(N)AC systems up to 0...500 V  
for undervoltage and overvoltage and under and overfrequency  
Software version: D345 V3.1x



Dipl.-Ing. W. Bender GmbH & Co. KG  
Londorfer Str. 65 • 35305 Grünberg • Germany  
Postfach 1161 • 35301 Grünberg • Germany

Tel.: +49 6401 807-0

Fax: +49 6401 807-259

E-Mail: [info@bender-de.com](mailto:info@bender-de.com)

Web: <http://www.bender-de.com>

## **BENDER Group**

© Dipl.-Ing. W. Bender GmbH & Co. KG

All rights reserved.

Reprinting only with permission  
of the publisher.

Subject to change!

---

# Table of Contents

<b>1. How to use this documentation effectively .....</b>	<b>5</b>
1.1 How to use this manual .....	5
<b>2. Safety .....</b>	<b>7</b>
2.1 General .....	7
2.2 Intended use .....	7
2.3 Skilled person .....	7
2.4 Safety information on work activities on electrical installations ..	8
<b>3. Function .....</b>	<b>9</b>
3.1 Device features .....	9
3.2 Function .....	10
3.2.1 Calculating the average value of overvoltage .....	10
3.2.2 Automatic self test .....	10
3.2.3 Manual self test .....	10
3.2.4 Functional faults .....	11
3.2.5 Fault memory .....	11
3.2.6 Assigning alarm categories to alarm relays K1/K2 .....	11
3.2.7 Time delays $t$ , $t_{on}$ and $t_{off}$ .....	11
3.2.8 Start-up delay $t$ .....	11
3.2.9 Response delay $t_{on}$ .....	11
3.2.10 Delay on release $t_{off}$ .....	12
3.2.11 Password protection (on, OFF) .....	12
3.2.12 Factory setting FAC .....	12
3.2.13 Erasable history memory .....	12
3.2.14 Alarm LEDs show which relay is in the alarm state .....	12
3.2.15 Starting a device using a simulated alarm S.AL .....	12
<b>4. Installation, connection and commissioning .....</b>	<b>15</b>

4.1	Installing the device .....	16
4.1.1	DIN rail mounting: .....	16
4.1.2	Screw mounting .....	16
4.2	Wiring of the device .....	17
4.3	Commissioning / factory setting .....	19
<b>5.</b>	<b>Operation and setting .....</b>	<b>21</b>
5.1	Getting to know the user interface .....	21
5.2	Understanding standard display indications .....	23
5.3	Getting to know keys and key functions .....	24
5.4	Querying values .....	25
5.5	Starting the self test manually .....	27
5.6	Clearing the fault memory .....	27
5.7	Calling up or leaving the menu .....	27
5.8	Carrying out settings in the menu .....	27
5.8.1	Password protection .....	27
5.8.2	Selecting menu items .....	29
5.8.3	Carrying out settings in the menu item AL .....	31
5.8.4	Carrying out settings in the menu item out .....	35
5.8.5	Carrying out settings in the menu item t .....	41
5.8.6	Carrying out settings in the menu item SET .....	42
5.8.7	Querying information in menu item INF .....	44
5.8.8	Querying and clearing fault memory in the menu item HIS .....	45
<b>6.</b>	<b>Technical data .....</b>	<b>47</b>
6.1	Data in tabular form .....	47
6.2	Standards, approvals and certifications .....	50
6.3	Ordering information .....	51
6.4	Label for modified versions .....	51
<b>INDEX</b>	<b>.....</b>	<b>53</b>

# 1. How to use this documentation effectively

## 1.1 How to use this manual

This operating manual is designed for skilled persons working in electrical engineering and electronics and must always be kept in an easily accessible location near to the equipment.

In order to make it easier for you to find specific text passages or references in this manual and for reasons of comprehensibility, important information is emphasised by symbols. The meaning of these symbols is explained below:



---

*Information calling attention to hazards are marked with this warning symbol.*

---



---

*Information intended to assist the user to make optimum use of the product are marked with the Info symbol.*

---



---

## 2. Safety

### 2.1 General

In addition to this manual, the documentation of the device includes a document entitled "Important safety instructions for Bender products".

### 2.2 Intended use

The voltage monitor VMD423H is used in 3(N)AC systems in accordance with VDE V 0126-1-1 for undervoltage, overvoltage, underfrequency and overfrequency monitoring. The device is suitable for the nominal voltage range  $U_n = 70...500$  V in the frequency range 40...65 Hz.

The device is internally supplied by the nominal voltage to be monitored.

### 2.3 Skilled person

Only electrically skilled persons are authorised to install and commission this device. Electrically skilled persons are those who have the relevant education, knowledge and experience, as well as knowledge of the relevant safety standards and who are able to perceive risks and to avoid hazards which electricity can create when work activities are carried out on electrical installations. The electrically skilled person is specially trained for carrying out work activities in his specific working environment and has a thorough knowledge of the relevant standards and regulations.

In Germany, an electrically skilled person must meet the requirements of the accident prevention regulation BGV A3. In other countries the applicable regulations have to be observed and followed.

## 2.4 Safety information on work activities on electrical installations



---

*Touching live parts will cause danger of electric shock with fatal consequences! All work activities on electrical installations as well as installation activities, commissioning activities and work activities with the device in operation may only be carried out by electrically skilled persons!*

---



---

*Danger of electric shock!  
Unprofessional work activities on electrical installations may result in a threat of danger to life and limb!*

---



## 3. Function

### 3.1 Device features

- The VMD423H is internally supplied by the nominal voltage  $U_n$
- Monitoring for undervoltage and overvoltage and underfrequency and overfrequency in 3(N)AC systems of AC 70...500 V / 70...288 V
- Monitoring of overvoltage  $U_2$  by average determination of the latest 10-minute measuring interval
- Asymmetry, phase failure and phase sequence monitoring
- Start-up delay, response delay and delay on release
- Adjustable switching hysteresis for the voltage to be monitored
- r.m.s. value measurement AC + DC
- Digital measured value display via multi-functional LC display
- LEDs: Power On, Alarm1 and Alarm2
- Fault memory for the operating value
- Cyclical self monitoring
- Internal test/reset button
- Two separate alarm relays (one changeover contact each)
- N/C or N/O operation and fault memory behaviour selectable
- Password protection for device settings
- Sealable transparent cover
- Available with screw-type or push-wire terminals
- Start-up of the device with or without simulated alarm message

## 3.2 Function

Once the nominal voltage is applied, the start-up delay plus response delay ( $t + t_{on1/2}$ ) begins. Throughout this time, an alarm is output via alarm LEDs and relays. Measured voltage and frequency values being changed during this start-up period  $t$  do not influence the alarm LEDs and the state of the alarm relays.

The devices utilise several separately adjustable measuring channels (over-voltage/undervoltage, overfrequency/underfrequency). When the measured value exceeds or falls below the response value, the alarm relays switch and the alarm LEDs light up. When the measured value exceeds or falls below the release value (response value plus hysteresis) after the alarm relays have switched, the selected release delay  $t_{off}$  begins. When  $t_{off}$  has elapsed, the alarm relays switch back to their initial position. With the fault memory activated, the alarm relays do not change their actual state until the reset button R is pressed. Also in the event of complete power failure of the system being monitored, the delay times are effective during the energy backup discharging time.

### 3.2.1 Calculating the average value of overvoltage

The overvoltage U2 is determined by calculating an average value of the last 10-minute measuring interval.

Always the highest average value U2 of each of the three voltages monitored between L1-N, L2-N, L3-N will be indicated.

### 3.2.2 Automatic self test

The device automatically carries out a self test after connection to the system to be monitored and later every hour. During the self test internal functional faults are detected and will appear in form of an error code on the display. The alarm relays are not tested during this time.

### 3.2.3 Manual self test

Pressing the test button for  $> 1.5$  s causes the device to carry out a self test where the internal functional errors are determined and shown on the display as error codes. The alarm relays are not tested during this time.

While the test button T is pressed and held down, all device-related display elements appear on the display.

### 3.2.4 Functional faults

If an internal malfunction occurs, all three LEDs flash. An error code will appear on the display (E01...E32). In such a case please contact the Bender Service.

### 3.2.5 Fault memory

The fault memory can be activated, deactivated or can be set to continuous mode (con). If the fault memory is set to "con" mode, the alarm parameters remain stored even on failure of the supply voltage.

### 3.2.6 Assigning alarm categories to alarm relays K1/K2

Different alarm categories can be assigned to the alarm relays K1/K2 via the menu "out". For details about alarm category assignment to the respective relays refer to the submenu out description on page 37.

### 3.2.7 Time delays $t$ , $t_{on}$ and $t_{off}$

The times  $t$ ,  $t_{on}$  and  $t_{off}$  described in the following delay the output of alarms via the LEDs and relays.

### 3.2.8 Start-up delay $t$

Once the supply voltage  $U_s$  has been switched on, the alarm indication is delayed by the preset time  $t$  (0...300 s).

### 3.2.9 Response delay $t_{on}$

When the value drops below or exceeds the response value, the voltage monitor requires the response time  $t_{an}$  until the alarm is activated.

A preset response delay  $t_{on}$  (0...300 s) adds up to the device-related operating time  $t_{ae}$  and delays alarm signalling (total delay time  $t_{an} = t_{ae} + t_{on}$ ).

If the fault no longer exists during the response delay, the alarm signal drops out.

### 3.2.10 Delay on release $t_{\text{off}}$

If the alarm no longer exists during the response delay and the fault memory is deactivated, the alarm LEDs will go out and the alarm relays switch back to their initial position. The delay on release (0...300 s) serves to maintain the alarm state signal for the set duration.

### 3.2.11 Password protection (on, OFF)

By default, the password protection is activated (on). Settings are only possible after entering the correct password (0...999). If you cannot operate your device because you cannot remember your password, please contact [info@bender-service.com](mailto:info@bender-service.com).

### 3.2.12 Factory setting FAC

After activating the factory setting, all settings previously changed are reset to delivery status.

### 3.2.13 Erasable history memory

The first alarm value to occur is saved in this memory. Subsequent alarms do not overwrite this "old" value. The memory can be cleared using the Clr key in the menu HiS. This function is not password protected.

### 3.2.14 Alarm LEDs show which relay is in the alarm state

When the menu item **LEd**  is activated, the alarm LED AL1 indicates that K1 is in the alarm state. When AL2 lights up, K2 is in the alarm state. An alarm relay cannot switch to the alarm state unless an alarm category has been assigned to it.

When the menu item **LEd**  is deactivated, AL1 signals overvoltage, AL2 signals undervoltage, both LEDs AL1 and AL2 light up in case of frequency alarm.

### 3.2.15 Starting a device using a simulated alarm S.AL

If the menu item S.AL has been activated in the out menu, K1 resp. K2 switches back to the alarm state once the nominal voltage is applied. This alarm state is maintained for the set duration  $t + t_{\text{on1}}$ . Once this time has elapsed, K1 resp.

K2 switches back to the initial position provided that no fault is detected at the measuring input.

The following diagrams show the effect of a fault during a simulated alarm.

Faults at the measuring input and the resulting condition of the alarm relay K1 (K2) are shown as a hatched area.

The fault for K1 shown in the time diagram below, by way of example, has started during the S.AL phase:

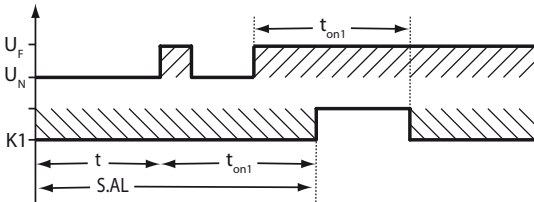

The fault for K1 shown in the time diagram below, by way of example, started when the S.AL phase has elapsed:

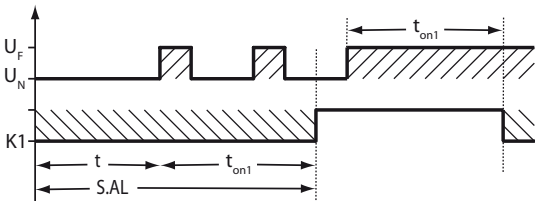



## 4. Installation, connection and commissioning



---

*Danger of electric shock! Make sure that the installation area is disconnected from any electrical source before starting installation works and that the nominal voltage and supply voltage specified in the relevant data sheet are observed!*

---

## 4.1 Installing the device

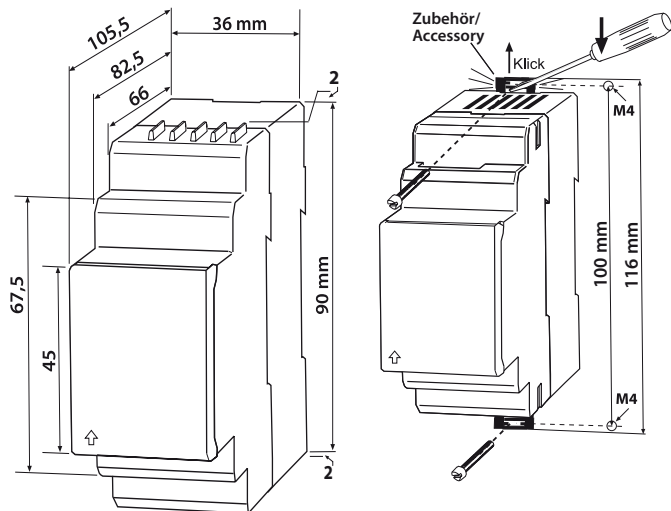

Fig. 4.1: Dimension diagram and drawing for screw fixing

### 4.1.1 DIN rail mounting:

1. Snap the rear mounting clip of the device into place in such a way that a safe and tight fit is ensured.

### 4.1.2 Screw mounting

1. Use a tool to move the rear mounting clips (a second mounting clip required, see ordering information) to a position that it projects beyond the enclosure.
2. Fix the device using two M4 screws.



## 4.2 Wiring of the device

Connect the device according the wiring diagram.

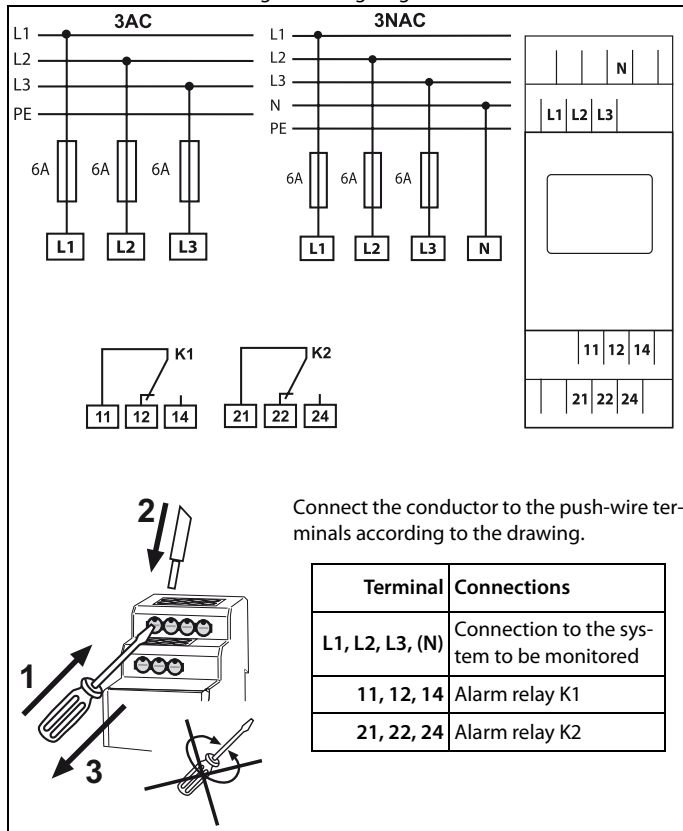

Fig. 4.2: Wiring diagram

## Example: Application of a photovoltaic system encountered in practice

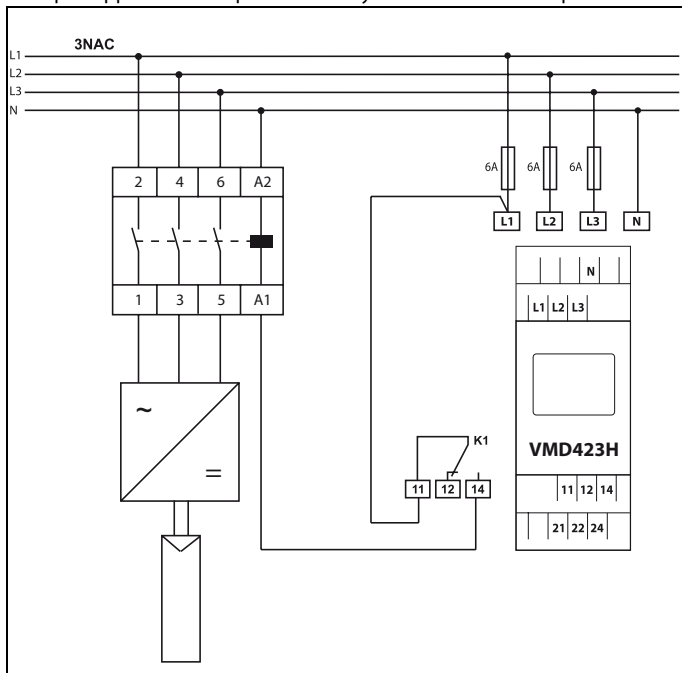

Fig. 4.3: Application of an VMD423-D-2 in a photovoltaic system.

Connect the terminals L1/L2/L3 of the VMD423H always to the supply side of the system to be monitored (but not to the inverter side of the disconnecting relay).

### 4.3 Commissioning / factory setting



*Material damage by improper connection of the device!  
Prior to commissioning make sure that the device is properly connected!*

---





Undervoltage < U:	184 V
Overvoltage > U1:	264 V
Overvoltage > U2 (10 min.):	253 V
Hysteresis U:	5 %
Underfrequency < Hz	47.5 Hz
Overfrequency > Hz	50.2 Hz
Hysteresis frequency (Hys Hz):	0.1 Hz
Fault memory M:	OFF
Operating principle K1	
(< U, > U1, Asy, < f, > f, S.AL):	N/C operation (n.c.)
Operating principle K2	
(Err, < U, > U1, > U2, Asy, < f, > f, PHS, S.AL):	N/C operation (n.c.)
AL1/AL2 indicate the alarm state of K1/K2 (LEd):	OFF
Alarm to K1/K2 (S.AL) when the device is started:	on
Asymmetry:	30 %
Phase sequence monitoring:	R, on
Start-up delay:	t = 30 s
Response delay:	t <sub>on1</sub> = 0,1 s t <sub>on2</sub> = 0,1 s
Delay on release:	t <sub>off</sub> = 30 s
Method of measurement:	3n (phase voltage measurement)
Password:	126, On



---

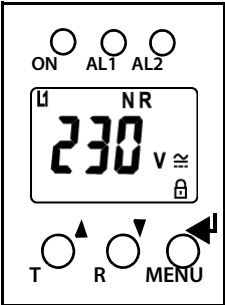

## 5. Operation and setting

### 5.1 Getting to know the user interface

Device front	Element	Function
	ON	Power On LED, green
	AL1, AL2	<b>Menu item LED  deactivated:</b> LED Alarm 1 lights (yellow): Response value > U reached LED Alarm 2 lights (yellow): Response value < U reached
	AL1 and AL2	<b>Menu item LED  deactivated:</b> Both LEDs light when the frequency response values > Hz or < Hz are reached.
	AL1, AL2	<b>Menu item LED  activated:</b> LED Alarm 1 lit up (yellow): K1 signals an arbitrary alarm LED Alarm 2 lights (yellow): K2 signals an arbitrary alarm
	230 V, M	Display in standard mode: $U_n = 230 \text{ V}$ ; Fault memory active
	T,  ▲	Test button (> 1.5 s): To indicate the display elements in use, to start a self test; Up key (< 1.5 s): Menu items/values

Device front	Element	Function
	R, 	Reset button (> 1.5 s): To delete the fault memory; Down key (< 1.5 s): Menu items/values
	MENU, 	MENU key (> 1.5 s): To start the menu mode; Enter key (< 1.5 s): To confirm menu item, submenu item and value. Enter key (> 1.5 s): To go back to the next higher menu level.

For further information about the menu item **LEd**  refer to page 12.

## 5.2 Understanding standard display indications





Fig. 5.1: Standard displays

- |  |  |
|--|--|
| <p>1 Indication LINE CONDUCTORS L1-L3:<br/>Shows the active line conductors.</p> <p>2 Indication ASYMMETRY:<br/>Shows the asymmetry value as %.</p> <p>3 Indication NEUTRAL CONDUCTOR:<br/>Neutral conductor is active.</p> <p>4 Indication PHASE SEQUENCE:<br/>R = clockwise<br/>L = anticlockwise</p> <p>5 Indication AREA FOR UNITS:<br/>Shows the value of a unit.<br/>% = per cent (asymmetry and hysteresis)<br/>Hz = frequency in hertz<br/>s = seconds<br/>k = kilo<br/>V = volt</p> | <p>6 Indication TYPE OF VOLTAGE:<br/>Shows the type of voltage.</p> <p>7 PASSWORD PROTECTION ENABLED:<br/>Indicates that password protection is activated.</p> <p>8 Indication OPERATING MODE:<br/>Shows the operating mode of K1/K2;<br/>resp. LEDs AL1/AL2 indicate the alarm statuses of K1/K2</p> <p>9 FAULT MEMORY ACTIVATED:<br/>Indicates that the fault memory is activated.</p> <p>10 Indication HYSTERESIS:<br/>Shows hysteresis as %.</p> <p>11 Indication VALUE:<br/>Shows values.</p> |
|--|--|

### 5.3 Getting to know keys and key functions

The following table shows the functions of the keys for navigation on the display, navigation through the menu and parameter setting. From "chapter 5.4 Querying values" onwards, only the respective key symbols are used for querying values.

Key	Key symbol	Function
UP		<ul style="list-style-type: none"> <li>• Call up the next display</li> <li>• Move to the next menu, sub menu or category</li> <li>• Activate parameters</li> <li>• Change the parameter value (increase)</li> <li>• Keep key pressed for more than 1.5 seconds: Carry out the manual self test.</li> </ul>
DOWN		<ul style="list-style-type: none"> <li>• Call up the next display</li> <li>• Move to the next menu, sub menu</li> <li>• Deactivate parameters</li> <li>• Change parameters (decrease)</li> <li>• Keep key pressed for more than 1.5 seconds: Clear fault memory.</li> </ul>
ENTER		<ul style="list-style-type: none"> <li>• Call up menu, submenu.</li> <li>• Save changed parameter value.</li> <li>• Keep key pressed for more than 1.5 seconds: Call up/leave the menu/ move to the next higher submenu item.</li> </ul>













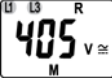

## 5.4 Querying values

By default, the phase voltage between L1 and N is indicated. By pressing the UP and DOWN key, the phase voltage between L1 and L3, L2 and L3 as well as asymmetry, system frequency and phase sequence as well as the average value of U2 can be queried.

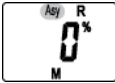

*The flashing elements in the display indications below are highlighted as grey-shaded fields.*

Query	Display indication
1. Query phase voltage L1/N	
2. Change display indication	
3. Query phase voltage L2/N	
4. Change display indication	
5. Query phase voltage L3/N	
6. Change display indication	

Query	Display indication
7. Query asymmetry	
8. Change display indication	
9. Query system frequency	
10. Change display indication	
11. Query phase sequence	
12. Change display indication	
13. Query average value of U2	

## 5.5 Starting the self test manually

The self test described on page 10 can also be started manually. During the self test, internal functional faults are detected and are indicated as error codes on the display. The alarm relays are not tested during this time. In order to start the self test manually:

1. Keep the test button T (UP) pressed for more than 1.5 seconds.



---

*On the display the text “tes” and all applicable display elements will appear.*

---

## 5.6 Clearing the fault memory

The device utilises an erasable fault memory.

In order to clear the fault memory:

- Keep the UP key pressed for more than 1.5 seconds.

## 5.7 Calling up or leaving the menu

In order to call up the menu:

- Keep the ENTER key pressed for more than 1.5 seconds.

For leaving the menu:

- Keep the ENTER key pressed again for more than 1.5 seconds.

## 5.8 Carrying out settings in the menu

### 5.8.1 Password protection

Please take into account that all the parameters for 3(N)AC 400 V systems are set by default according to VDE V 0126-1-1. Parameters can only be changed when a password has been entered before. Enter the password by keeping the UP or DOWN key pressed. The password enables you to make further settings until you leave the menu.

The graphic below shows the principle of password entry.

In this case, we assume, the response value for undervoltage is to be changed. During the sequence of operation, you need to confirm the password entry before carrying out the next step in the operation.

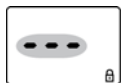

## 5.8.2 Selecting menu items

Press the ENTER key for more than 1.5 seconds to call up the menu. Menu items for different settings are available. Some menu items consist of several submenu items. The UP/DOWN keys can be used to navigate through the menu items. Keep the ENTER key pressed no longer than 1.5 seconds to call up the menu item. Keep the ENTER key pressed for more than 1.5 seconds to return to the next higher menu level.

### Menu item/ENTER key Description/parameter setting



Querying and setting response values:

- Undervoltage: < U (AL2)
- Overvoltage: > U1 (AL1)
- Overvoltage: > U2 (AL1) (10 minutes)
- Hysteresis of the voltage response values: Hys U
- Asymmetry: Asy (AL1 and AL2)
- Underfrequency: < Hz (AL1 and AL2)
- Overfrequency: > Hz (AL1 and AL2)
- Hysteresis of the frequency response values: Hys Hz
- Phase sequence: PHS (AL1 and AL2)



1. Press the UP/DOWN key to select the next menu item.



Configuring the fault memory and the alarm relays:

- Activate/deactivate the fault memory or select con mode
- Select N/O operation (n.o.) or N/C operation (n.c.) individually for each K1/K2
- After activating the menu item **LEd**  the LEDs AL1/AL2 show alarm statuses of any kind for K1/K2
- Assign the alarm categories undercurrent, overcurrent, underfrequency, overfrequency or device error individually to each K1/K2 (1, r1 / 2, r2)
- Assign the alarm function individually to K1/K2 (1, r1/2, r2) when starting the device (S.AL)

## Menu item/ENTER key Description/parameter setting



2. Press the UP/DOWN key to select the next menu item.



Adjust delays:

- Response delay  $t_{on1}/t_{on2}$
- Start-up delay  $t$
- Delay on release  $t_{off}$  (LED, relay)



3. Press the UP/DOWN key to select the next menu item.



Setting the parameters for device control

- Select method of measurement 3Ph or 3n
- Enable or disable password protection, change password
- Re-establish factory setting
- Service menu SyS blocked



4. Press the UP/DOWN key to select the next menu item.



Query hard and software version



5. Press the UP/DOWN key to select the next menu item.

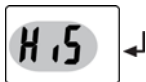

Query stored alarm values















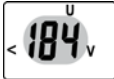



6. Press the UP/DOWN key to select the next menu item.















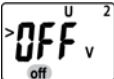

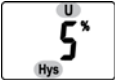

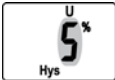



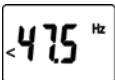
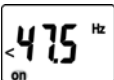

Move to the next higher menu level (return)

### 5.8.3 Carrying out settings in the menu item AL

1. Select menu item AL.
2. Carry out parameter change as illustrated below.
3. Keep the ENTER key pressed for more than 1.5 seconds to return to the menu item level after parameter change.

Menu item AL	Select submenu item	Activate/deactivate parameters	Change display parameter value	Change/save parameter.
1. Set the response value for undervoltage				
				
2. Select submenu item				
3. Set the response value for undervoltage1				
				
4. Select submenu item				

Menu item	Select submenu item	Activate/deactivate parameters	Change display parameter value	Change/save parameter.
5. Set the response value for undervoltage2				
				
6. Select submenu item				
7. Set the hysteresis for voltage response values				
8. Select submenu item				
9. Set the asymmetry response value				
10. Select submenu item				
11. Set the response value for underfrequency				
				



Menu item AL	Select submenu item	Activate/deactivate parameters	Change display parameter value	Change/save param.
12. Select submenu item				
13. Set the response value for overfrequency				
14. Select submenu item				
15. Set the hysteresis for frequency response value				
16. Select submenu item				
17. Set the response value for phase sequence				
18. Select submenu item				

**Menu item**  
**AL**

Select submenu item

Activate/deactivate pa-  
rametersChange display  
parameter valueChange/save par-  
am.

19. Return to menu  
item AL



### 5.8.4 Carrying out settings in the menu item out

1. Select menu item out.
2. Carry out parameter change as illustrated below.
3. Keep the ENTER key pressed for more than 1.5 seconds to return to the menu item level after parameter change.

Menu item out	Select submenu item	Activate/deactivate/ change param.	Change display parameter value	Change/save par- am.
---------------	---------------------	---------------------------------------	-----------------------------------	-------------------------

1. Enable fault memory/select con mode

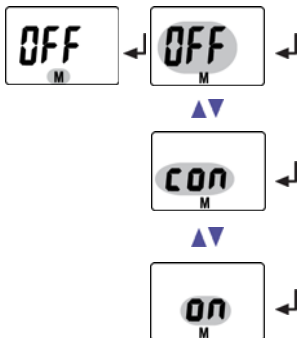

2. Activate/deactivate fault memory or select con mode

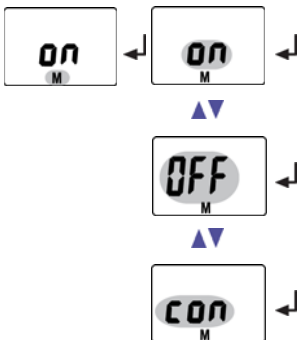

**Menu item  
out**

Select submenu item

 Activate/deactivate/  
change param.

 Change display  
parameter value

 Change/save par-  
am.

3. Select sub-  
menu item



4. Setting the  
alarm relay K1  
to N/O opera-  
tion (n.o.)

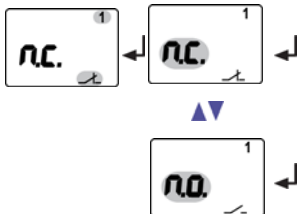

5. Setting the  
alarm relay K1  
to N/C opera-  
tion (n.c.)

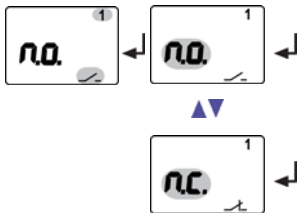







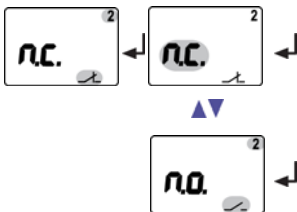







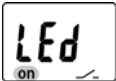

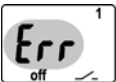
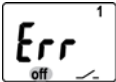

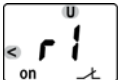
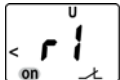

6. Select sub-  
menu item

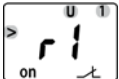
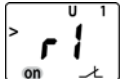

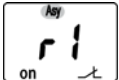
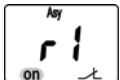

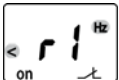
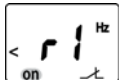

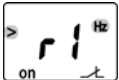
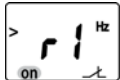











7. Setting the  
alarm relay K2  
to N/O opera-  
tion (n.o.)



Menu item out	Select submenu item	Activate/deactivate/ change param.	Change display parameter value	Change/save param.
8. Set alarm relay K2 to N/C operation (n.c.)				
9. Select submenu item				
10. LEDs AL1/AL2 show the alarm status of K1/K2				
11. Select submenu item				
12. Assign category device error to alarm relay K1				
13. Change category				

Menu item out	Select submenu item	Activate/deactivate/ change param.	Change display parameter value	Change/save param.
14. Assign undervoltage fault to alarm relay K1				
15. Change category				
16. Assign overvoltage fault1 to alarm relay K1				
17. Change category				
18. Assign asymmetry fault to alarm relay K1				
19. Change category				
20. Assign underfrequency fault to alarm relay K1				
21. Change category				
22. Assign overfrequency fault to alarm relay K1				

Menu item out	Select submenu item	Activate/deactivate/ change param.	Change display parameter value	Change/save param.
23. Change category				
24. Assign phase sequence fault to alarm relay K1				
25. Change category				
26. Assign overvoltage fault2 to alarm relay K1				
27. Change category				
28. Assign simulated alarm to alarm relay K1 when starting the device				
29. Change category				
30. Return to submenu item r1				
31. Select submenu item				

**Menu item out**

Select submenu item

 Activate/deactivate/  
change param.

 Change display  
parameter value

Change/save param.

32. Assign category device error to alarm relay K2



← Assignment is carried out in exactly the same way as for alarm relay K1

33. Select submenu item















34. Return to menu item out

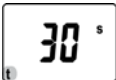



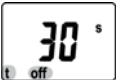



### 5.8.5 Carrying out settings in the menu item t

1. Select menu item t
2. Carry out parameter change as illustrated below.
3. Keep the ENTER key pressed for more than 1.5 seconds to return to the menu item level after parameter change.

Menu item t	Select submenu item	Activate/deactivate pa- rameters	Change display pa- rameter value	Change/save par- am.
1. Set the response delay for K1 (set $t_{on2}$ just like $t_{on1}$ )		→		
2. Select submenu item				
3. Set start-up delay for device start		→		
4. Select submenu item				
5. Set delay on release K1/K2		→		
6. Select submenu item				
7. Return to menu item t				

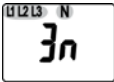
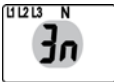
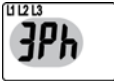
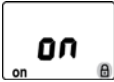
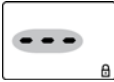
## 5.8.6 Carrying out settings in the menu item SET

1. Select menu item SET.
2. Carry out parameter change as illustrated below.
3. Keep the ENTER key pressed for more than 1.5 seconds to return to the menu item level after parameter change.

Menu item SET	Select submenu item	Activate/deactivate/change param.	Change display parameter value	Change/save param.
1. Set method of measurement for phase				
2. Select submenu item				
3. Changing the password				

Menu item SEt	Select submenu item	Activate/deactivate/ change param.	Change display parameter value	Change/save param.
------------------	---------------------	---------------------------------------	-----------------------------------	--------------------

4. Disable password protection

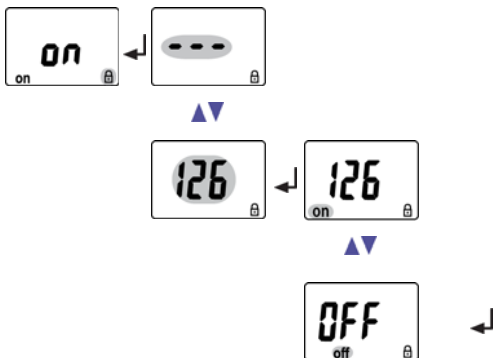



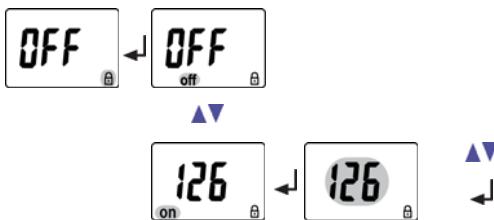



5. Enable password protection and enter password (3-digit numerical code)



6. Select submenu item

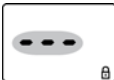

Menu item SEt	Select submenu item	Activate/deactivate/ change param.	Change display parameter value	Change/save param.
7. Re-establish factory setting		←		
		▲▼		←
				The text "run" will appear on the display and the device will automatically reset to factory setting.
8. Select sub- menu item		▲▼		
9. System menu locked		← →		▲▼
				←
10. Select sub- menu item		▲▼		
11. Return to menu item SEt		←		









### 5.8.7 Querying information in menu item INF

1. Select menu item INF.

Information such as software version and hardware version will alternately appear on the display. Select the respective information from the text indicated on the display using the UP/DOWN keys.

### 5.8.8 Querying and clearing fault memory in the menu item HIS

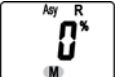
1. Select menu item HIS.
2. Change parameters according to table.
3. Keep the ENTER key pressed for more than 1.5 seconds to return to the menu item level after parameter change.

Menu item HiS	Fault indication /Submenu item
1. Query voltage error L1/N	
2. Select fault indication	
3. Query voltage error L2/N	
4. Select fault indication	
5. Query voltage error L3/N	
6. Select fault indication	
7. Query asymmetry faults	
8. Select fault indication	

**Menu item HiS**

Fault indication /Submenu item

9. Query frequency fault  
(overfrequency)

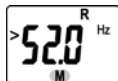

10. Select fault indication



11. Indicate average value  
(L2 or L3 can also be indicated)



12. Select fault indication



13. To clear the fault memory



14. Select fault indication



15. Return to menu item HiS



## 6. Technical data

### 6.1 Data in tabular form

( )\* = factory setting

#### Insulation coordination acc. to IEC 60664-1 / IEC 60664-3

Rated insulation voltage .....	400 V
Rated impulse voltage/pollution degree .....	4 kV / III
Protective separation (reinforced insulation) between .....	(N, L1, L2, L3) - (11, 12, 14) - (21, 22, 24)
Voltage test acc. to IEC 61010-1:	
(N, L1, L2, L3) - (11, 12, 14) .....	3.32 kV
(N, L1, L2, L3) - (21, 22, 24) .....	2.21 kV

#### Supply voltage

Supply voltage $U_s$ .....	none (internally supplied by $U_n$ )
Power consumption .....	$\leq 5$ VA

#### Measuring circuit

Measuring range (r.m.s. value) (L-N) .....	AC 0...288 V
Measuring range (r.m.s. value) (L-L) .....	AC 0...500 V
Rated frequency $f_n$ .....	40...65 Hz
Frequency range .....	25...100 Hz**

#### Response values

Type of distribution system .....	3(N) AC / 3 AC (3 AC)*
Undervoltage $< U$ (Alarm 2) (measurement method: 3Ph/3n) .....	AC 70...500 V / 70...288 V (3n: AC 184 V)*
Overvoltage $> U_1$ (Alarm 1) (measurement method: 3Ph/3n) .....	AC 70...500 V / 70...288 V (3n: AC 264 V)*
Overvoltage $> U_2$ (Alarm 1) (measurement method: 3Ph/3n) .....	AC 70...500 V / 70...288 V (3n: AC 253 V)*
Overvoltage $U_2$ .....	10-minute average determination
Resolution of setting $U$ .....	1 V
Hysteresis $U$ .....	1...40 % (5%)*
Asymmetry .....	5...30 % (30%)*
Phase failure .....	by setting of the asymmetry
Phase sequence .....	clockwise R/anticlockwise L (R / on)*

Relative uncertainty, voltage at 50 Hz/60 Hz.....	$\pm 1.5\%$ , $\pm 2$ digits
Underfrequency < Hz .....	45...65 Hz (47.5 Hz)*
Overfrequency > Hz .....	45...65 Hz (50.2 Hz)*
Resolution of setting f .....	0.1 Hz
Hysteresis frequency Hys Hz .....	0.1...2 Hz (0.1 Hz)*
Relative uncertainty frequency in the range of 40...65 Hz .....	$\pm 0.1\%$ , $\pm 1$ digit

## Specified time

Start-up delay t .....	0...300 s (30 s)*
Response delay $t_{on1/2}$ .....	0...300 s (0,1 s)*
Delay on release $t_{off}$ .....	0...300 s (30 s)*
Resolution of setting t, $t_{on1/2}$ , $t_{off}$ (0...10 s) .....	0.1 s
Resolution of setting t, $t_{on1/2}$ , $t_{off}$ (10...99 s) .....	1 s
Resolution of setting t, $t_{on1/2}$ , $t_{off}$ (100...300 s) .....	10 s
Operating time voltage $t_{ae}$ .....	$\leq 80$ ms
Operating time frequency $t_{ae}$ .....	$\leq 80$ ms
Response time $t_{an}$ .....	$t_{an} = t_{ae} + t_{on1/2}$
Discharging time energy backup on power failure .....	$\geq 2.5$ s
Charging time energy storage .....	$\leq 60$ s
Recovery time $t_b$ .....	$\leq 300$ ms

## Displays, memory

Display .....	LC display, multi-functional, not illuminated
Display range, measured value.....	AC 0...500 V
Operating uncertainty, voltage at 50 Hz/60 Hz .....	$\pm 1.5\%$ , $\pm 2$ digits
Operating uncertainty in the frequency range of 40...65 Hz .....	$\pm 0.1\%$ , $\pm 1$ digit
History memory (HIS) for the first alarm value.....	data record measured values
Password .....	Off/on / 0...999 (on/126)*
Fault memory (M) alarm relay .....	on/off/con (OFF)*

## Switching elements

Number of changeover contacts .....	2 x 1 (K1, K2)
Operating principle .....	N/C operation n.c. / N/O operation n.o.
.....	K1: (undervoltage < U, overvoltage > U1, asymmetry Asy,
.....	underfrequency < Hz, overfrequency > Hz, alarm when starting S.AL, N/C operation n.c.)*
.....	K2: (device error Err, undervoltage < U, overvoltage > U1, asymmetry Asy,



..... underfrequency < Hz, overfrequency > Hz, phase sequence PHS ,  
 ..... overvoltage > U<sub>2</sub>, alarm when starting S.AL, N/C operation n.c.)\*

Electrical endurance ..... 10000 switching operations

Contact data acc. to IEC 60947-5-1:

Utilisation category	AC 13	AC 14	DC-12	DC-12	DC-12
Rated operational voltage	230 V	230 V	24 V	110 V	220 V
Rated operational current	5 A	3 A	1 A	0.2 A	0.1 A
Minimum contact rating	1 mA at AC/DC ≥ 10 V				

## Environment/EMC

EMC	IEC 61326
Operating temperature	-25 °C...+55 °C
Classification of climatic conditions acc. to IEC 60721:	
Stationary use (IEC 60721-3-3)	3K5 (except condensation and formation of ice)
Transportation (IEC 60721-3-2)	2K3 (except condensation and formation of ice)
Long-time storage (IEC 60721-3-1)	1K4 (except condensation and formation of ice)
Classification of mechanical conditions acc. to IEC 60721:	
Stationary use (IEC 60721-3-3)	3M4
Transport (IEC 60721-3-2)	2M2
Long-time storage (IEC 60721-3-1)	1M3

## Connection

Connection	<b>screw-type terminals</b>
Connection properties:	
rigid/ flexible	0.2...4 / 0.2...2.5 mm <sup>2</sup> / AWG 24...12
Multi-conductor connection (2 conductors with the same cross section):	
rigid, flexible	0.2...1.5 / 0.2...1.5 mm <sup>2</sup>
Stripping length	8...9 mm
Tightening torque	0.5...0.6 Nm
Connection	<b>push-wire terminals</b>
Connection properties:	
rigid	0.2...2.5 mm <sup>2</sup> (AWG 24...14)
Flexible without ferrules	0.2...2.5 mm <sup>2</sup> (AWG 24...14)
Flexible with ferrules	0.2...1.5 mm <sup>2</sup> (AWG 24...16)
Stripping length	10 mm
Opening force	50 N

Test opening, diameter ..... 2.1 mm

### General data

Operating mode ..... continuous operation

Mounting ..... any position

Degree of protection, internal components (IEC 60529) ..... IP30

Degree of protection, terminals (IEC 60529) ..... IP20

Enclosure material ..... polycarbonate

Flammability class ..... UL94 V-0

DIN rail mounting acc. to ..... IEC 60715

Screw fixing ..... 2 x M4 with mounting clip

Software version ..... D345 V3.1x

Weight ..... ≤ 240 g

( ) \* = factory setting

## 6.2 Standards, approvals and certifications



### 6.3 Ordering information

Device type	Nominal voltage $U_n^*$	Art. No.
VMD423H-D-3 (push-wire terminals)	3(N)AC 70...500 V/ 288 V 40...65 Hz	B 7301 0022
VMD423H-D-3	3(N)AC 70...500 V/ 288 V 40...65 Hz	B 9301 0022
*Absolute values of the voltage range		
Mounting clip for screw fixing (1 piece per device, accessories)		B 9806 0008

### 6.4 Label for modified versions

There will only be a label in this field if the device is different from the standard version.





# INDEX

## A

Alarm LEDs show which relay is in the alarm state 12

Automatic self test 10

## C

currently measured values

- asymmetry 25
- phase sequence 25
- Phase voltage 25
- Query average value of U2 26
- system frequency 25

## D

Delay on release toff 12

Deleting the fault alarms 22

Discharging time energy backup on power failure 48

## E

Enter key 22

## F

Factory setting 12, 19

Fault memory in the operating mode on, off or con 11

Function 10

Functional faults 11

## G

Getting 21

## H

How to use this manual 5

## I

Indication of the alarm state of K1/K2 12

Installation and connection 15

## K

Key functions 24

Keys 24

## L

LED Alarm 1 lights 21

LED Alarm 2 lights 21

## M

Manual self test 10, 27

Manual, target group 5

Menu item AL 31

Menu item HIS 45

Menu item INF 44

Menu item LEd 12

Menu item OUT 35

Menu item SET 42

Menu item t 41

Menu, call up 27

Menu, leave 27  
Menu, settings 27  
Mounting clip for screw fixing 51

## O

Operating elements, function 21  
Operation and setting 21  
Ordering information 51

## P

Password protection 12  
Preset function 10

## Q

Querying values 25

## R

Reset button 22  
Response delay ton 11

## S

S.AL 12  
Selecting menu items 29  
simulated 12  
Simulated alarm S.AL 12  
Standard display indications 23  
Starting the menu mode 22  
Start-up delay t 11

## T

Technical data 47  
Test button 21  
Time delays 11

To clear the fault memory 27

## U

User interface 21

## W

Wiring diagram 17  
Work activities on electrical installations 8





**Dipl.-Ing. W. Bender GmbH & Co. KG**

Londorfer Str. 65 • 35305 Grünberg • Germany

Postfach 1161 • 35301 Grünberg • Germany

Tel.: +49 6401 807-0

Fax: +49 6401 807-259

E-Mail: [info@bender-de.com](mailto:info@bender-de.com)

Web: <http://www.bender-de.com>

---