

Manual



RCMA426H-DCB

Residual current monitor
for monitoring AC, DC and pulsed DC currents
in earthed and resistance earthed systems
Software version D312 V1.0x



Bender GmbH & Co. KG

P.O. Box 1161 • 35301 Gruenberg • Germany

Londorfer Str. 65 • 35305 Gruenberg • Germany

Tel.: +49 6401 807-0

Fax: +49 6401 807-259

E-Mail: info@bender.de

Web: <http://www.bender.de>

© Bender GmbH & Co. KG

All rights reserved.

Reprinting only with permission
of the publisher.

Subject to change!

Table of Contents

1. Making effective use of this document	5
1.1 How to use this manual	5
1.2 Intended use	5
2. Safety instructions	7
2.1 General safety instructions	7
2.2 Work activities on electrical installations	7
3. Function	9
3.1 Device features	9
3.2 Description of function	9
3.2.1 Transformer monitoring	10
3.2.2 Quick query of the rated residual operating current	11
3.2.3 Self test, automatic	11
3.2.4 Self test, manual	11
3.2.5 Malfunction	11
3.2.6 Password protection (on, OFF)	12
3.2.7 Factory setting FAC	12
3.2.8 Erasable history memory HiS	12
3.2.9 RS-485 interface	12
4. Installation and connection	13
4.1 Dimension diagrams	13
4.2 Factory setting	15
4.3 Commissioning	15
5. Operation and configuration	17
5.1 Getting to know the user interface	17
5.2 Understanding information on the standard display	18
5.3 Getting to know buttons and button functions	19

5.4	Starting a manual self test	20
5.5	Erasing the fault memory	20
5.6	Calling up and exiting the menu	20
5.7	Making settings in the menu	21
5.7.1	Selecting menus	21
5.7.2	Querying the software version with the InF menu	22
5.7.3	Setting the bus address	22
5.7.4	Making settings in the SEt menu	23
5.7.5	Querying and erasing the fault memory in the HIS menu	26
6.	Technical data	27
6.1	Data RCMA426H-DCB-2 in table form	27
6.2	Error codes	30
6.3	Recommended contactors	31
6.4	Response times of the RCMA426H system plus contactor in accordance with UL943	32
6.5	Ordering information	33
6.6	Standards, approvals and certifications	34
6.7	Label for modified versions	34
INDEX	35

1. Making effective use of this document

1.1 How to use this manual

This manual has been designed for electrically skilled persons working in electrical engineering and electronics!

To make it easier for you to understand and revisit certain sections of text and instructions in the manual, we have used symbols to identify important instructions and information. Examples of how such symbols are used appear below:



Information calling attention to hazards are marked with this warning symbol.



Information intended to assist the user to make optimum use of the product are marked with the Info symbol.

1.2 Intended use

The AC/DC sensitive residual current monitor RCMA426H-DCB with its internal measuring current transformer is used to monitor earthed and resistive-earthed systems (TN and TT systems) in which DC and AC fault currents may occur. These systems involve loads with six-pulse bridge rectifiers or half-wave rectifiers with smoothing, e.g. converters and chargers.

In the event of a rated residual current $I_{\Delta n}$ of 6 mA, the device will switch an alarm relay and the associated contactor in accordance with the operating time specified in UL943.

2. Safety instructions

2.1 General safety instructions

In addition to these operating instructions, the "Important safety instructions for Bender products", which are also included in the scope of supply, are an integral part of the device documentation.

2.2 Work activities on electrical installations

- Only skilled persons are permitted to carry out the work necessary to install, commission and run a device or system.
- Compliance with applicable regulations governing work on electrical installations, and with the regulations derived from and associated with them, is mandatory. EN 50110 is of particular importance in this regard.



Failure to carry out work on electrical installations properly and correctly can put life and limb at risk!

- If the device is being used in a location outside the Federal Republic of Germany, the applicable local standards and regulations must be complied with. European standard EN 50110 can be used as a guide.

3. Function

3.1 Device features

- AC/DC sensitive residual current monitor with internal 13 mm measuring current transformer
- Can be used in conjunction with a contactor
- Rated residual operating current $I_{\Delta n} = 6 \text{ mA}$ acc. to UL943
- Operating time acc. to UL943
- r.m.s. value measurement, frequency range 0...150 Hz
- Measured value display via multi-functional LCD
- Alarm signalling via LEDs (TPD, ERR) and K2 changeover contact
- Password protection to prevent unauthorised changes being made to device settings
- Permanent fault memory
- N/C operation of alarm relay
- Device test when the power supply voltage is connected
- Automatic self test every 24 h
- CT connection monitoring
- RS-485 interface can be terminated with switch
- Internal test circuit acc. to UL943 without additional external components
- Internal test and reset button
- N-PE conductor monitoring on the load side

3.2 Description of function

The RCMA426H-DCB runs a device test when the power supply voltage is connected. During the start-up phase, the TRP LED lights up, the alarm LED ERR flashes and the alarm relay switches to the alarm setting.

Once the device test has been completed successfully, the ERR alarm LED will stop flashing, the TPD LED will go out and the alarm relay will return to the normal setting.

The device will check the circuit for the presence of residual currents even during the self test.

An internal measuring current transformer is used for residual current measurement. The actual measured value is indicated on the LCD. If the rated residual operating current of 6 mA is exceeded, the alarm relay K2 will change to the alarm state and the TRP alarm LED will light up.

Once the alarm relay has switched, the residual current must fall to less than the rated residual operating current.

If it does not, error code E.04 will appear on the display and the ERR alarm LED will flash. This means that the connected contactor has not shut down the faulty circuit.

If the residual current falls below the release value, the error will continue to be signalled due to the permanently activated fault memory. The alarm relay K2 will not switch back to the initial state and the TRP alarm LED will not go out until the reset button R is pressed or the power supply voltage is interrupted.

Parameters are assigned to the device via the LCD and the control buttons on the front panel; this function can be password-protected.

A reset is also possible via the RS-485 by activating the reset command, for example, via an externally connected MK2430 alarm indicator and test combination.

3.2.1 Transformer monitoring

The connections to the measuring current transformer are checked periodically every 10 s for short and open circuits. In the event of an error, the alarm relay K2 will switch, the red TPD alarm LED will light up and the yellow ERR alarm LED will flash (error codes E.01 or E.03). Once the error has been eliminated, the alarm LEDs and the alarm relay will remain in the alarm state. Pressing the reset button R or sending a reset command via the RS-485 interface will switch K2 back to its initial state and the alarm LEDs will go out.

3.2.2 Quick query of the rated residual operating current

When the display is in standard mode, the rated residual operating current $I_{\Delta n} = 6 \text{ mA}$ can be queried by pressing the Up or Down button ($< 1.5 \text{ s}$). Switching to menu mode is not necessary. Quick query mode can be exited by pressing Enter ($< 1.5 \text{ s}$).

3.2.3 Self test, automatic

The device runs a self test every 24 h. Any internal malfunctions detected are shown on the display as error codes. The automatic self test is carried out without internal fault current. The alarm relay is not switched during the 24-h test.

3.2.4 Self test, manual

The device runs a self test when the test button is pressed ($> 1.5 \text{ s}$). Any internal malfunctions detected are shown on the display as error codes.

Whilst the test button T is pressed, all display elements available for this device are shown. When the button is released, the tES test symbol appears and the manual self test commences.

During the manual self test, an internal test current of approx. 7 mA is evaluated. Consequently, the TPD alarm LED lights up and the alarm relay switches. Once the alarm relay has switched, the residual current must fall to less than the rated residual operating current. If it does not, error code E.04 will appear on the display to indicate that the connected contactor has not shut down the load circuit.

If the self test has been successfully and the reset button R is pressed, the alarm LEDs will go out and the relay will switch to its initial state.

If the self test has not been successfully, the TPD alarm LED will light, the ERR alarm LED will flash, the alarm relay will switch to the alarm state and an error code will be displayed.

3.2.5 Malfunction

In the event of an internal malfunction, the TPD alarm LED will light and the ERR alarm LED will flash. An error code will appear on the display until the fault is removed. Refer to page 30 for details about error codes.

3.2.6 Password protection (on, OFF)

If password protection has been activated (on), settings can only be made subject to the correct password being entered (0...999).

3.2.7 Factory setting FAC

Activating the factory setting will reset all modified settings, with the exception of the device address, to the default upon delivery.

3.2.8 Erasable history memory HiS

The first alarm value to occur is written to this memory. The memory can be erased via the HiS menu.

3.2.9 RS-485 interface

The interface provides the device with a means of communicating with an alarm indicator and test combination (e.g.: MK2430). The ability to output up-to-date measured values and alarms is just one of the features supported. Test and reset commands can be sent to the RCMA426H-DCB from the MK2430.

4. Installation and connection



Make sure that the installation area has been de-energised and ensure compliance with the regulations for working on electrical installations.

4.1 Dimension diagrams

RCMA426H-DCB dimension diagram and drawing for screw fixing

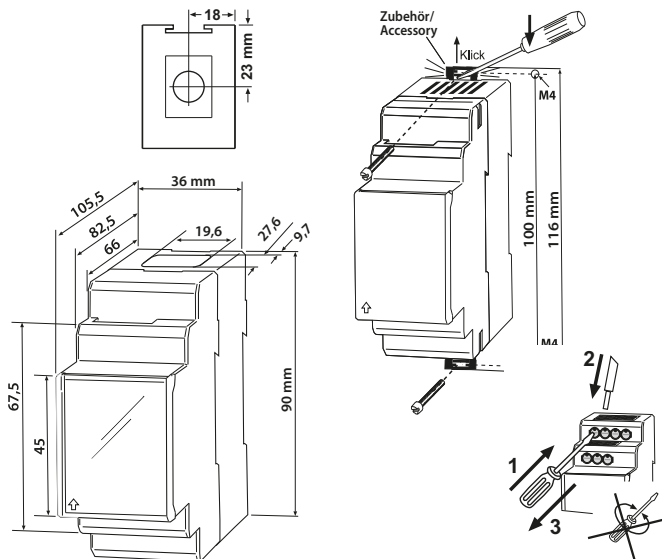

The front plate cover is easy to open at the lower part marked by an arrow.

1. Mounting on a DIN rail:

Snap the mounting clip at the rear of the device onto the DIN rail so that it sits securely.

Screw fixing:

Using the tool, position the rear mounting clips (a second mounting clip is required, see the ordering information) so that it protrudes over the enclosure. Fix the device in place with two M4 screws.

2. Wiring

The device must be wired as illustrated in the wiring diagram (example).

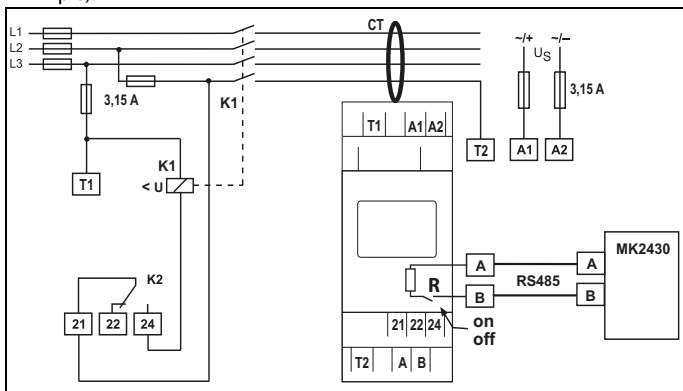

Terminal	Connections
A1, A2	Connection to the power supply
T1, T2	Test connections for internal monitoring circuit
A, B	RS-485-interface can be terminated with switch R
21, 22, 24	Alarm relay K2: Connection to contactor or load switch
CT	Internal measuring current transformer: D = 13 mm
K1	Recommended contactors are listed in the table on page 31

4.2 Factory setting



<i>Rated residual operating current, fixed value:</i>	<i>6 mA</i>
<i>Hysteresis, fixed value:</i>	<i>15 %</i>
<i>Bus address:</i>	<i>2</i>
<i>Bus terminating resistor R:</i>	<i>Off</i>
<i>Fault memory M:</i>	<i>permanently activated</i>
<i>Mode of operation K2:</i>	<i>permanent</i>
	<i>N/C operation (n.c.)</i>
<i>Password:</i>	<i>0, deactivated (Off)</i>

4.3 Commissioning

Checks must be carried out prior to commissioning to ensure that the residual current monitor, the external measuring current transformer and the associated contactors and peripherals have been connected correctly.



Incorrect connections can lead to personal injury and damage to equipment or property!

5. Operation and configuration

5.1 Getting to know the user interface



Abb.5.1: User interface

- 1 Green Power ON LED:
Lights up when the power supply voltage is connected and the device is running.
- 2 Red TPD alarm LED:
Lights up when the rated residual operating current $I_{\Delta n}$ is exceeded.
- 3 Yellow ERR alarm LED:
Flashes in the event of system errors. An error code will appear on the display, e.g. E.03
- 4 DISPLAY:
Displays operating information.
- 5 ENTER (< 1.5 s) / MENU (> 1.5 s) button:
Press this button to apply entries and changes and call up the menu.
- 6 DOWN (< 1.5 s) / RESET (> 1.5 s) button:
Press this button to reduce input values and navigate through the menu, as well as to perform a reset.
- 7 UP (< 1.5 s) / TEST (> 1.5 s) button:
Press this button to increase input values and navigate through the menu, as well as to run a manual self test.

5.2 Understanding information on the standard display

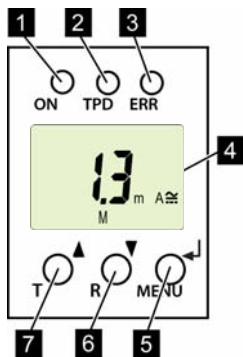

Abb.5.1: Standard display

- 1 Measured value display in mA:
- 2 Current type display AC / DC
- 3 Password protection activated
- 4 Fault memory activated

The actual measured residual current is displayed by default.

Press the Up or Down button to display the factory-set rated residual operating current $I_{\Delta n}$. Pressing the Enter button restores the measured value.

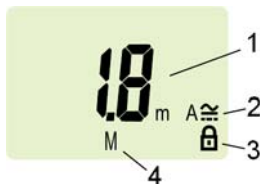

In standard operation, the display can be toggled to the fixed rated residual operating current $I_{\Delta n}$ of 6 mA using the Up/Down button.

5.3 Getting to know buttons and button functions

The table below lists the functions of the buttons when navigating through the display, navigating through the menu and when making settings. From "chapter 5.7 Making settings in the menu" in the menu onwards, just the relevant button symbol is used to indicate that buttons have been pressed.

Button	Button symbol	Function
Up/ Test	▲ T	<ul style="list-style-type: none"> • Call up next display • Go to the next menu/submenu/category item • Activate parameter • Change (increase) parameter value • Press and hold down button for more than 1.5 seconds: run manual self test
Down/ Reset	▼ R	<ul style="list-style-type: none"> • Call up next display • Go to next menu/submenu • Deactivate parameter • Change (reduce) parameter value • Press and hold down button for more than 1.5 seconds: erase fault memory
ENTER/ Menu	↵ MENU	<ul style="list-style-type: none"> • Call up menu/submenu • Apply modified parameter value • Press and hold down button for more than 1.5 seconds: Call up menu/exit menu/go to next highest submenu

5.4 Starting a manual self test

You can start a self test manually. During the test, any internal malfunctions detected are shown on the display as error codes. The alarm relay will be switched.

To start a self test manually:

- Press and hold down the test button T (UP) for more than 1.5 seconds.



The text "tES" appears on the display along with all available display elements.

5.5 Erasing the fault memory

The device has an erasable fault memory.

To erase the fault memory:

- Press and hold down the reset button (DOWN) for more than 1.5 seconds.

5.6 Calling up and exiting the menu

To call up the menu:

- Press and hold down the MENU (ENTER) button for more than 1.5 seconds.

To exit the menu again:

- Press and hold down the MENU (ENTER) button again for more than 1.5 seconds.









The areas of the display which can be configured flash! This is indicated by an oval marker in the illustrations below. Press and hold down the MENU button > 1.5 s to enter menu mode.

5.7 Making settings in the menu

5.7.1 Selecting menus

Press and hold down the MENU button for more than 1.5 seconds to call up the menu. Menus are available for a variety of settings. In turn, each menu has a number of submenus. The UP/DOWN buttons can be used to navigate between menus. Press and hold down the ENTER button for less than 1.5 seconds to call up a menu. Press and hold down the ENTER button for more than 1.5 seconds to go to the next highest menu.

Menu/Button to call	Description/Configurable parameters
	Query software version
	1. Press the UP/DOWN buttons to go to the menu
	Set bus address
	2. Press the UP/DOWN buttons to go to the menu
	Assign device control parameters <ul style="list-style-type: none"> • Activate or deactivate password protection, change password • Restore factory settings • Service menu SyS (locked)
	3. Press the UP/DOWN buttons to go to the menu
	Query saved alarm value, erase history memory

Menu/Button to call	Description/Configurable parameters
---------------------	-------------------------------------



4. Press the UP/DOWN buttons to go to the menu



Go to the next highest menu level (Back)



5.7.2 Querying the software version with the InF menu

1. Select the InF menu
2. Confirm with Enter

The software version (e.g.: d312-1.00). Once all information is showing on the display, you can use the UP/DOWN buttons to select individual items.

5.7.3 Setting the bus address

1. Select the Adr. menu.
2. Make changes to parameters as illustrated.
3. To go back to the menu level, press and hold down the ENTER button for more than 1.5 seconds once you have modified the parameter(s).

Menu	Select submenu	Change parameter value display	Change/apply param.
Bus address setting			









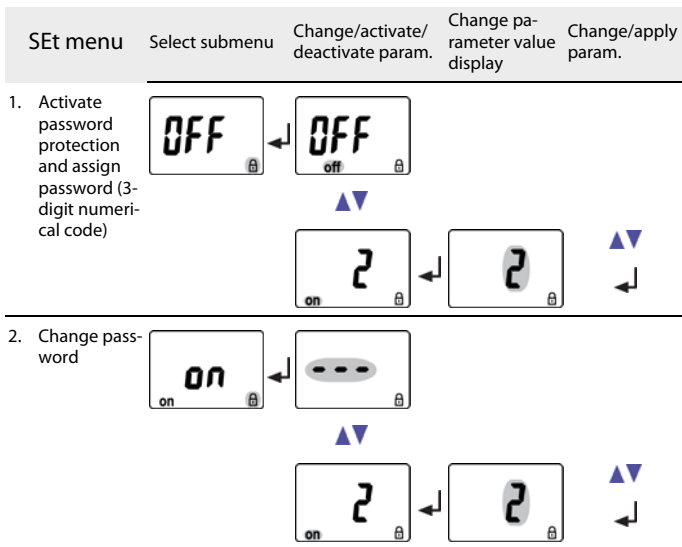

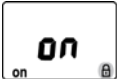
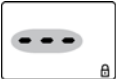



5.7.4 Making settings in the SEt menu

This menu can be used to activate password protection, to modify the password or to deactivate password protection. It is also where the device can be reset to the factory settings.

1. Select the SEt menu.
2. Make changes to parameters as illustrated.

To go back to the menu level, press and hold down the ENTER button for more than 1.5 seconds once you have modified the parameter(s).



S/Et menu	Select submenu	Change/activate/ deactivate param.	Change pa- rameter value display	Change/apply param.
3. Deactivate password protection				
				
4. Switch submenu				
5. Restore factory setting				"run" appears on the display and the device is reset to the factory settings automatically.
				
6. Switch submenu				

SEt menu

Select submenu

Change/activate/
deactivate param.Change pa-
rameter value
displayChange/apply
param.

7. System menu
(is locked)



8. Switch sub-
menu









9. Go back to
SEt menu



5.7.5 Querying and erasing the fault memory in the HIS menu

1. Select the HIS menu.
2. Select the saved error and erase if applicable.
3. To go back to the menu level, press and hold down the ENTER button for more than 1.5 seconds.

HiS menu	Error display/Submenu
1. Error: Rated residual operating current exceeded	
2. Switch error display	
3. Error code E.03 see page 30	
4. Switch error display	
5. Erase fault memory	
6. Switch error display	
7. Go back to HiS menu	

6. Technical data

6.1 Data RCMA426H-DCB-2 in table form

()* = factory setting

Insulation coordination acc. to IEC 60664-1 / IEC 60664-3

Rated insulation voltage	250 V
Oversvoltage category/ pollution degree.....	III/3
Rated impulse voltage.....	4 kV
Protective separation (reinforced insulation) between.....	(A1, A2) - (k/I, T/R) - (21, 22, 24)
Voltage tests according to IEC 61010-1.....	2.21 kV

Supply voltage

Supply voltage range U_s	AC/DC 100... 250 V
U_s	AC/DC 70... 300 V
Frequency range U_s	42... 460 Hz
Power consumption	≤ 6.5 VA

Measuring circuit

Internal measuring current transformer, diameter	13 mm
Rated voltage (measuring current transformer)	2.5 kV
Rated frequency	0... 150 Hz
AC/DC measuring range	0... 40 mA
Relative uncertainty 0... 20 Hz	-33 %... +100 %
Relative uncertainty 20... 90 Hz	0... -33 %
Relative uncertainty 90... 150 Hz	± 17.5 %

Response value

Rated residual operating current $I_{\Delta n}$	6 mA
---	------

Time behaviour

Start-up delay t	operating time $t_{ae} + 3.2$ s
Operating time t_{ae} acc. to UL943	see diagram on page 32

Displays, memory

Display range. AC/DC measured value	0 ... 40 mA
Resolution of setting	0.1 mA
Error of indication 0 ... 20 Hz	-33 % ... +100 % / ± 2 digits
Error of indication 20 ... 90 Hz	0 ... 20 % / ± 2 digits
Error of indication 90 ... 150 Hz	± 17.5 % / ± 2 digits
Error of indication at $I_{\Delta} < 2$ mA	± 7 digits
Measured value memory for alarm value (HiS)	Measured values data set
Password	off / 0 ... 999 / 0 (off)*

Interface

Interface/protocol	RS-485 / proprietary
Baud rate	9.6 kbit / s
Cable length	0 ... 1200 m
Recommended cable (shielded, shield connected to PE at one end)	at least J-Y(St)Y 2 x 0.6
Terminating resistor, can be switched	120 Ω , 0.25 W (off)*
Bus address	2 ... 90 (2)*

Switching elements

Number of switching elements	1 changeover contact
Operating principle	N/C operation n.c.
Electrical service life under rated operating conditions	10000 switching cycles
Contact data acc. to IEC 60947-5-1	
Utilisation category	AC-13 AC-14 DC-12 DC-12 DC-12
Rated operational voltage	230V 230V 24V 110V 220 V
Rated operational voltage UL	200V 200V 24V 110V 200 V
Rated operational current	5 A 3 A 1 A 0.2 A 0.1 A
Minimum contact rating	1 mA at AC/DC ≥ 10 V

Environment / EMC

EMC	UL943
Operating temperature	-35 °C ... +66 °C
Climatic class acc. to IEC 60721	
Stationary use (IEC 60721-3-3)	3K5 (except condensation and formation of ice)
Transport (IEC 60721-3-2)	2K3 (except condensation and formation of ice)
Long-term storage (IEC 60721-3-1)	1K4 (except condensation and formation of ice)

Classification of mechanical conditions acc. to IEC 60721:

Stationary use (IEC 60721-3-3)	3M4
Transport (IEC 60721-3-2)	2M2
Long-term storage (IEC 60721-3-1)	1M3

Connection

For UL application use 60/70 °C copper conductors only

Connection type **screw terminals**

rigid/ flexible/ conductor sizes 0.2...4 / 0.2...2.5 mm² / AWG 24...12

Multi-conductor connection (2 conductors with the same cross section)

rigid, flexible 0.2...1.5 / 0.2...1.5 mm²

Stripped length 8...9 mm

Tightening torque 0.5...0.6 Nm

Connection type **push-wire terminals**

Connection properties:

rigid 0.2...2.5 mm² (AWG 24...14)

Flexible without ferrules 0.2...2.5 mm² (AWG 24...14)

Flexible with ferrules 0.2...1.5 mm² (AWG 24...16)

Stripped length 10 mm

Opening force 50 N

Test opening, diameter 2.1 mm

Other

Operating mode continuous operation

Position of normal use display-oriented

Degree of protection, internal components (IEC 60529) IP30

Degree of protection, terminals (IEC 60529) IP20

Enclosure material polycarbonate

Flammability class UL94V-0

DIN rail mounting acc. to IEC 60715

Screw fixing 2 x M4 with mounting clip

Software version D312 V1.0

Weight ≤ 150 g

()* = factory setting

6.2 Error codes



If, contrary to expectations, a device error should occur, error codes will appear on the display. Some of these are described below:

Error code	Meaning
E.01	Error: transformer connection
E.02	System connection fault after finishing manual self test
E.03	Fault CT connection monitoring
E.04	Error following powering up the device: Contactor does not open Action: Check contactor: e.g. contacts sticking, release coil faulty
E...	Error codes > 04 Action: Perform a reset. Restore the device to the factory setting. Should the error persist, contact Bender Service.

The error code will be erased automatically once the error has been eliminated.

6.3 Recommended contactors

The ABB types listed below have undergone performance testing:

Contactor type	Main contact	Auxiliary contact	
			
A16-30-10-84	3	1	
A26-30-10-84	3	1	
A40-30-10-84	3	1	
A75-30-00-84	3		
A110-30-00-84	3		
A145-30-00-84	3		
A16-30-10-34	3	1	
A26-30-10-34	3	1	
A40-30-10-34	3	1	
A75-30-00-34	3		
A110-30-00-34	3		
A145-30-00-34	3		
A16-40-00-84	4		
A26-40-00-84	4		
A45-40-00-84	4		
A75-40-00-84	4		
EK150* -40-22	4	2	2
A16-40-00-34	4		
A26-40-00-34	4		
A45-40-00-34	4		
A75-40-00-34	4		
EK150** -40-22	4	2	2

6.4 Response times of the RCMA426H system plus contactor in accordance with UL943

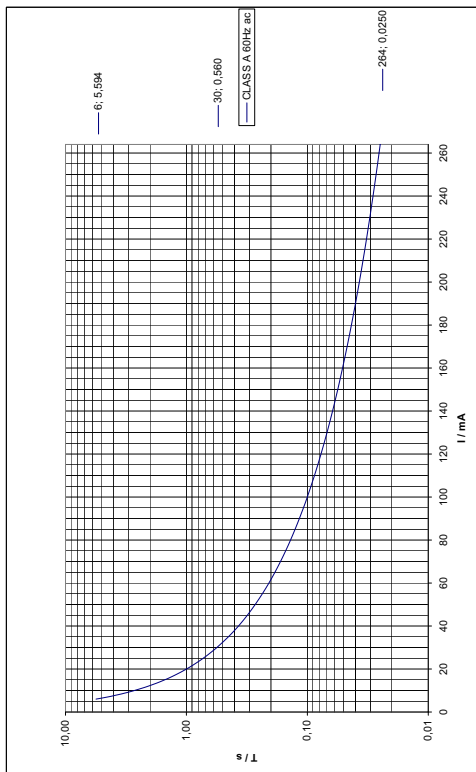

6.5 Ordering information

	RCMA426H-DCB-2
Rated residual operating current $I_{\Delta n}$	6 mA
Rated frequency	0...150 Hz
Supply voltage U_S^*	AC/DC 70...300 V AC 42...460 Hz
Art. No.: with screw terminal with push-wire terminal	B 9404 3020 B 7404 3020
*Absolute values of the voltage range	

RCMA426H-DCB accessories

Mounting clip for screw fixing (1 per device)..... B 9806 0008

External alarm indicator and test combination

Type	Art. No.
MK2430A-12 $U_S = AC 18...28 V / DC = 18...30 V$	B 9510 0006

6.6 Standards, approvals and certifications



6.7 Label for modified versions

There will only be a label in this field if the device is different from the standard version.

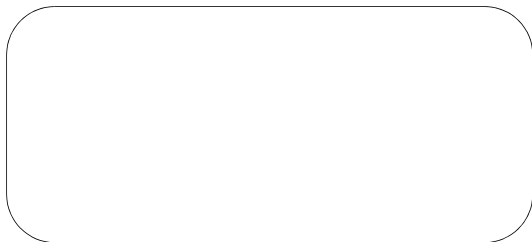

INDEX

A

Accessories 33
Adr menu 22

B

Button functions 19

C

Commissioning 15

D

Description of function 9
Device features 9
Device test 9
Dimension diagrams 13

E

Error codes 30

F

Factory setting 12, 15

H

HiS menu 26
History memory 12
How to use this manual 5

I

Installation and connection 13

M

Malfunction 11
Manual, target group 5
Menu, settings 21
Multi-conductor connection 29

O

Operation and configuration 17
Ordering information 33

P

Parameter setting
- Activating or deactivating the password protection 23
Password protection 12
Push-wire terminal 29

Q

Querying and erasing the fault memory 26
Quick query of the rated residual operating current 11

R

Recommended contactors 31
Response times 32
Restore factory settings 24
RS-485 interface 12

S

- screw terminals 29
- Self test, automatic 11
- Self test, manual 11, 20
- Set bus address 22
- SEt menu 23

T

- Technical data 27
- To call up the menu 20
- To exit the menu 20

W

- Wiring diagram 14
- Work activities on electrical installations 7

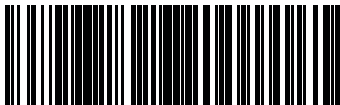

D0006600MXXEN



Bender GmbH & Co. KG

P.O. Box 1161 • 35301 Gruenberg • Germany

Londorfer Str. 65 • 35305 Gruenberg • Germany

Tel.: +49 6401 807-0

Fax: +49 6401 807-259

E-Mail: info@bender.de

Web: <http://www.bender.de>

BENDER Group
